

GROSS LOAD CAPACITY WHEN USED AS A WEIGHT CARRYING HITCH: 5,000 LBS. TRAILER WEIGHT & 500 LBS. TONGUE WEIGHT.
GROSS LOAD CAPACITY WHEN USED AS STRAIGHT LINE PULL: 9,000 LBS. MAX. LINE PULL.

DO NOT EXCEED VEHICLE MANUFACTURER'S RECOMMENDED TOWING CAPACITY.***

Parts List			
ITEM	QTY	PART NUMBER	DESCRIPTION
1	4	1/2 - 13	HEX FLANGE NUT
2	4	1/2-13 x 1 1/4	HEX BOLT

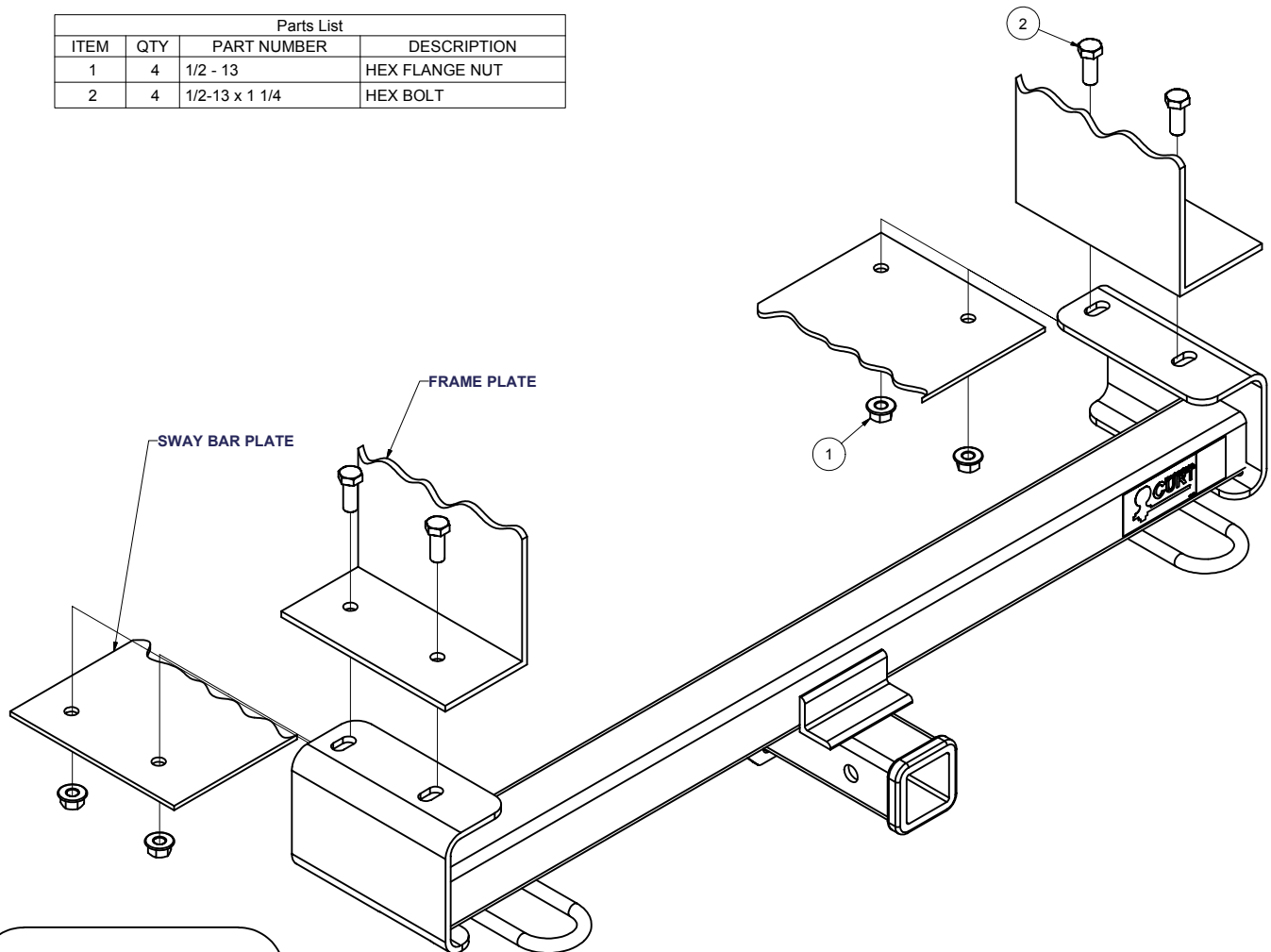

HITCH WEIGHT: 36 LBS.

INSTALL TIME: 30 MINUTES

INSTALL NOTES:

INSTALLATION STEPS

- 1) Remove bolts that fasten sway bar to frame plate and discard. Enlarge hole in sway bar plate to 1/2".
- 2) Loosely fasten receiver assembly to frame using existing nut plate and the supplied hardware, as shown.
- 3) Torque 1/2" fasteners to 72 lb.-ft.

PERIODICALLY CHECK THIS RECEIVER HITCH TO ENSURE THAT ALL FASTENERS ARE TIGHT AND THAT ALL STRUCTURAL COMPONENTS ARE SOUND.

*****DO NOT EXCEED VEHICLE MANUFACTURER'S RECOMMENDED TOWING CAPACITY ***.**

FRONT MOUNTED ACCESSORIES

1) Do not exceed front axle Gross Weight Rating (GAWR). Consult owners manual or specification plate located on driver's door frame. Measure gross front axle weight by placing front wheels of loaded vehicle on a scale.

WARNING: Exceeding GAWR may overload the front axle and/or suspension. This could result in **accident, property damage and personal injury.**

- 2) Reposition front mounted license plate if obstructed.
- 3) Do not obstruct vehicle lights.
- 4) Allow free air flow into grille opening.
- 5) Rear wheel traction may be reduced. This could effect handling. Reduce speed and drive with caution.
- 6) Accessories extend front of vehicle. This may reduce approach angle. Use caution when parking and maneuvering.
- 7) Do not obstruct driver view.

VEHICLE RECOVERY AND WINCHING TIPS

1) Use OEM tow hooks, recovery eyes or a clevis mount for attachment of a tow strap or winch cable.

WARNING: NEVER use a ball and/or ball mount as an anchor point for tow strap or winch cable. Severe personal injury or death could result.

- 2) Observe winch manufacturer's recommendations, cautions and warnings.
- 3) Attach return cable to tow hook or recovery eye when using a snatch block (See figure 1).

CAUTION: Do not attach return cable to winch mount. This may overload winch mount and/or front mounted receiver.

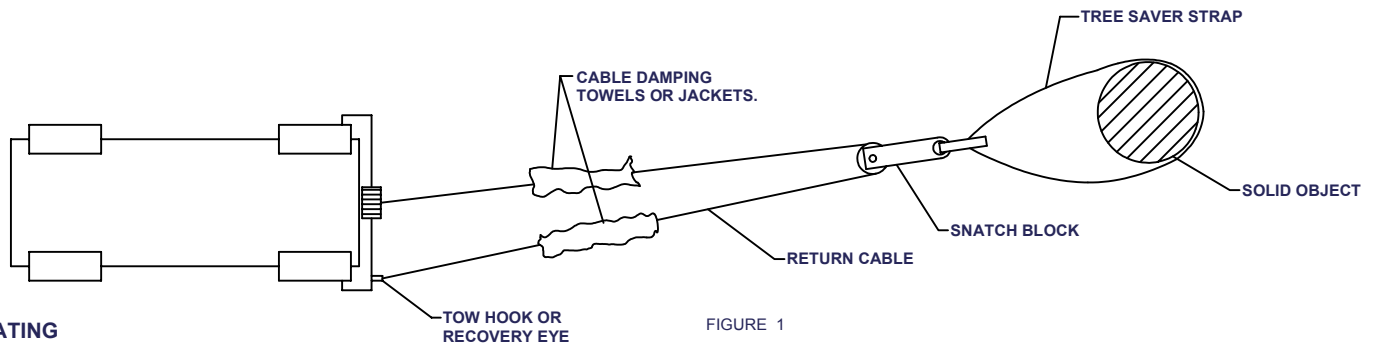

RATING

- For **Maximum** line pull rating, winch cable must not exceed:
- 15 degree angle up or down from horizontal (See Figure 2).
 - 45 degree angle left or right from straight ahead (See Figure 3).

CAUTION: Exceeding the maximum line pull rating may over load winch, winch mount, and/or front mounted receiver.

